



2-card, 4-card, and 6-card chassis



21-card chassis

## Features and Benefits

- Extend your KVM stations and computers
  - Up to 460ft (140m) using CATx cable
  - Up to 3,300ft (1Km) using multi-mode fiber
  - Up to 33,000ft (10Km) using single-mode fiber
- Multiple chassis sizes satisfies both large and small system configurations
- Use USB keyboard, mouse, touchscreen, and most HID devices or use option cards to add printers, scanners, hard drives, memory sticks, audio devices, and others
- Video interfaces available:
  - Single-link DVI-D video up to 1920×1200@60Hz
  - Dual-link DVI-D video up to 4K@30Hz
  - Dual-head DVI video using one cable up to 1920×1200@60Hz
  - DVI-I (VGA) video up to 1920×1200@60Hz with optional scaling
  - HDMI video up to 4K@60Hz
  - DisplayPort video up to 4K@60Hz
  - SDI video up to 1920×1080p
- Other interfaces available
  - USB-HID, USB 2.0, and USB 3.0 devices
  - PS2 keyboard and mouse
  - Serial RS-232 and RS-422, up to 115.2Kbaud
  - Analog stereo microphone and speaker
  - Digital audio (Mini-XLR, Coaxial, Optical)
- Other options:
  - Redundant power
  - Redundant link

## Product Overview

The modular design of the Orion XTender allows users to extend desktop control of remote computers or to relocate them in a secure and managed space away from desktop, control room, or hazardous environments.

Whether you need single, dual, or quad-head video displays with control from a USB or PS2 keyboard, mouse, or touchscreen, this modular and feature packed family can be configured to fit your needs.

Common applications include control rooms, broadcast studios, outside broadcast vans, concert and theatre venues, AV distribution, medical imaging, and other industrial/military applications.

Run them point to point or connect them to an Orion-X or Orion-XC switch. Now you can route your video, audio, and USB control to whatever destination desired. Your source and destination video format need not be the same.

A wide range of chassis sizes with provision for redundant power makes the Orion XT a versatile product. You can use the larger sizes where multiple sources are in the same location and use the smaller units to spread around your facility near the users.

Connection status LED's are located on the front panel to indicate the operating status of the unit. The chassis are all rack mountable and all connectors are on the same side of the chassis for convenience and ease of access.

**Planning your installation** To ensure the proper components are specified, first, decide if the application is for a point-to-point extension or a KVM switching system. For KVM switching, the Orion XTender units connect to the Orion digital KVM switch (see separate datasheet). Next, determine the number of transmitter (CPU) and receiver (user) connection points required and choose how to distribute these using the 2, 4, 6, or 21 card chassis. The density of the chassis types will impact decisions such as power, cabling access and rack space allocation.

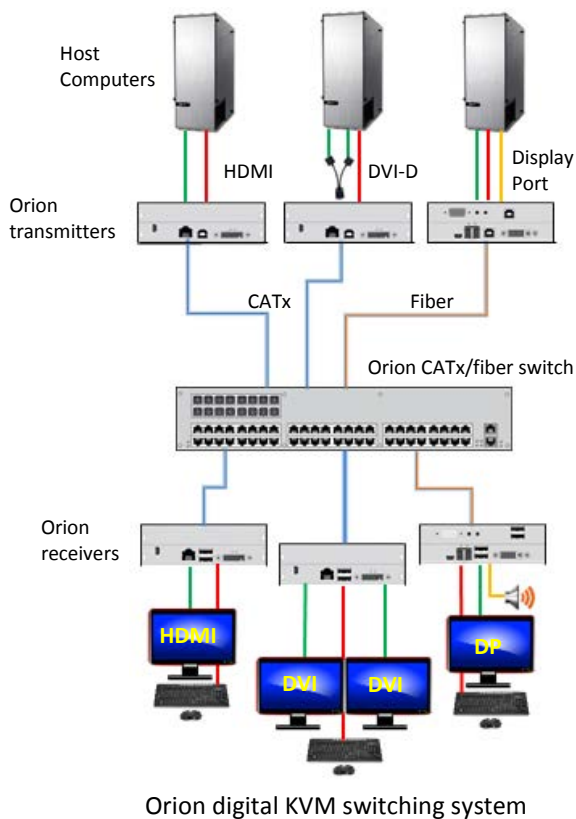
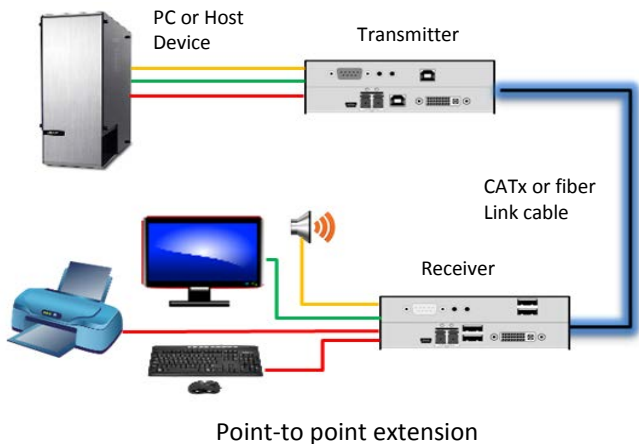

**Main and Option Cards** All Orion XTender main cards have a link-port, either RJ45 for CATx or Duplex LC for fiber. Most main cards have a video connector and a USB-HID connector, 1× B type for the transmitter and 2× A type for the receiver. The Orion XTender option cards are installed on top of the main cards. The option cards get power from and use the same link cable as the main card.

**USB** There are several ways to transport USB. The USB-HID on the main card handles keyboards and mice, bar-code scanners, touch screens, and similar types of devices. To go beyond that, you can add either an embedded USB option card (uses the link on the main card for transport) or a separate higher speed USB2.0 or USB3.0 card (has its own dedicated link).

The embedded USB option cards come in two types: one with two device ports at rates up to 36Mbps and one with four device ports at rates up to 100Mbps. The high-speed USB2.0 cards with dedicated links allow for rates up to 480Mbps. A USB powered hub can be added to expand the number of supported USB2.0 devices.

The USB3.0 card supports lossless extension of USB3.0 SuperSpeed devices including high-speed memory cards and cameras up to 5Gbps. It is available with a dedicated single-mode fiber optic link up to 330ft (100m) using multimode fiber.

**Audio, Serial, PS/2** A range of analog and digital audio cards are available for the Orion XTender. The analog audio card supports bi-directional stereo audio transmission with a line-level interface. The digital audio option transports digital audio using mini-XLR, coaxial, and optical interfaces. Also available is a balanced audio card for professional audio devices.

The serial interface RS-232 and RS-422 cards support a full duplex transmission rate of up to 115,200 Baud with hardware handshake. PS/2 keyboard and mouse is also available. These options are often mixed together on one option card to save space.

**Display settings** The default settings are normally satisfactory for most display connections. If needed, the EDID information can be obtained from the displays or loaded to the unit from a binary file. Generally, no configuration is needed.

**Link interface** CATx cabling should be similar in quality to that used for Gigabit Ethernet installations, pinned to EIA/TIA 568-B. The use of solid core AWG24 shielded CAT5e (or better) is recommended. For fiber, there are two data rates, 1G (1.25Gbps bit rate) and 2.5G (3.125Gbps bit rate). The higher speed fiber provides higher quality video that is used for higher resolutions with more demanding applications. Both fiber interfaces have single mode optics which can use either multi-mode or single-mode fiber cable.

**Redundant link transmission** The redundant link option, with shared video, keyboard, mouse, audio and serial data, features twin CATx or fiber link cables that can be used in two different ways:

**Use for mission critical installations** The redundant link provides a backup link should the primary link fail.

**Share PC access with two remote users** In this case, the TX unit would be equipped with a redundant link, and the two receivers would be standard Orion receiver chassis. The two users contend for control of the PC based on a keyboard/mouse timeout function, configurable up to 10 seconds.

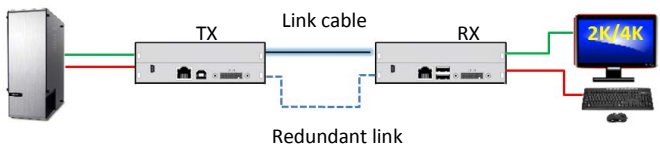

Redundant link used as a backup link

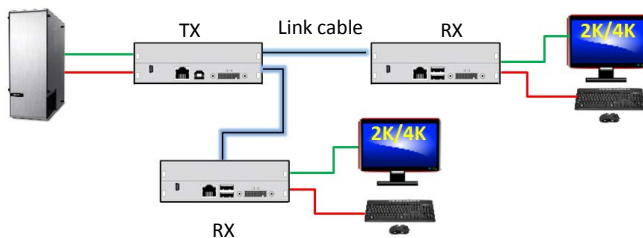

Two users sharing the resources of a common PC

**DVI-I (VGA) video** The Orion DVI-I transmitter unit converts VGA input to a digital signal for transmission to the receiver unit. When the video input resolution is passed-through or with limited scaling, the output video can be either VGA or DVI. The DVI-I dual-height transmitter card with video management OSD can scale the VGA input to any DVI output up to 2048x1152@60Hz. These card options are particularly useful for integrating and upgrading older VGA video devices into a distributed digital video system.

**Dual-link DVI video** These Orion XTender cards support high resolution DVI dual-link video up to 4K@30. Video resolutions supported include 2048x2048@60, 2560x1440@60, 2560x2048@60, 3840x2160@30, 4096x2160@30.

A short 1ft (0.3 meter) DMS59 to DVI-D cable is provided at each end to interface the DMS-59 connector to a standard DVI-D cable. The link cable can be CATx, or single-mode fiber at 1Gbps or 2.5Gbps.

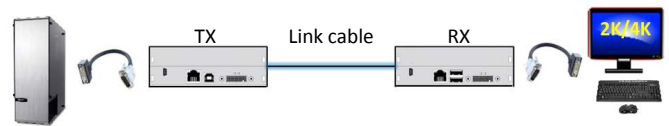

Orion XTender dual-link video extension

**Dual-head DVI video** The dual-head transmitter and receiver kit uses a DMS59 to 2 x DVI-D “Y Cable” at each end to interface to two DVI connectors. When the computer is configured for dual-head video operation, the user can operate the host PC using a single keyboard and mouse. Dual-head video output is at 1920x1200 on each port. Data rate is limited to 165 MPixel/s. The link cable can be CATx, or fiber at 1Gbps or 2.5Gbps.

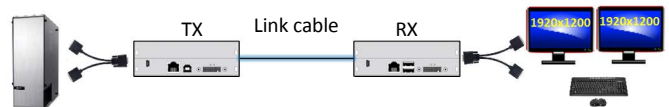

Orion XTender dual-head video extension

**HDMI video only extension** The HDMI video only card enables HDMI video and embedded audio to be transmitted using CATx or fiber cable over extended distances at 1080p/2K video bandwidth. When combined with a Rose Electronics HDMI video splitter, the single HDMI output signal can be sent to multiple displays in remote locations.

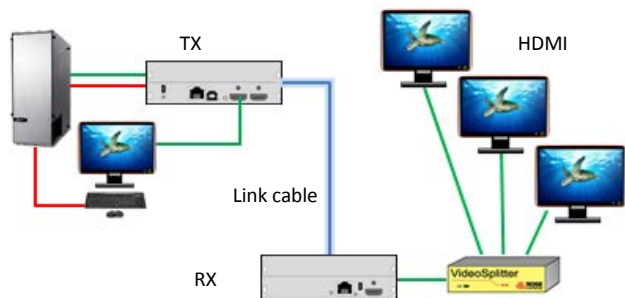

Orion HDMI video extension with video splitter

**HDMI remote computer switching** The HDMI receiver with switch function includes a 2-port KVM switch for the local connection of a PC or laptop at the user station. Using keyboard commands, the user has the convenience of switching between the host computer and the local computer at the work location.

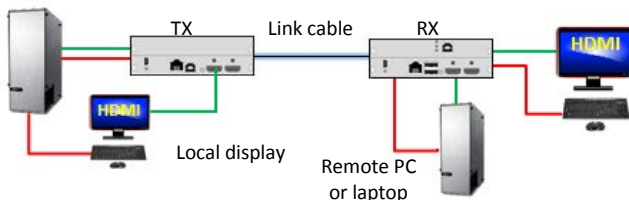

Orion HDMI KVM extension with remote PC connection

**HDMI local video** This HDMI main card transmitter provides an HDMI loop out at the source for connection of a local monitor. This is particularly helpful when setting up and managing the HDMI video input in close proximity to the video source. This card does not support Orion XTender option cards.

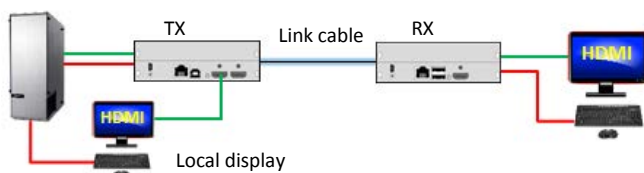

**DisplayPort video** There are three types of DisplayPort extenders. Standard performance models support DisplayPort 1.1. Two high performance models are for DisplayPort 1.1 or 1.2. The DisplayPort 1.2 models use 2.5G fiber only.

**SDI video** The SDI models support 3G/HD/SD data rates. The unit has dual video to support dual-head or to use a loopback option for a local monitor. Additional features include video scaling, interlacing, de-interlacing, and programmable signal format of SMPTE 424M level A or B.

**Mixed video interfaces** You can use one type of video at the transmit end and another type at the receive end. The Orion XTender will extend and convert the video. For example, a dual-link DVI input can connect to a HDMI or DisplayPort display and an SDI input can connect to an HDMI display.

#### Embedded audio

The HDMI, DisplayPort, and SDI models support embedded audio and can output audio to a display with built-in speakers or through an analog audio or digital audio option card. You can also connect audio through one of these option cards at the source with video that does not support embedded audio such as DVI or VGA.

**Chassis options** Chassis are available to fit up to 2, 4, 6, or 21 cards per unit. Within each of these chassis sizes there are further provisions for redundant and DC power. Only the 6-card chassis with IEC connectors and the 21-card chassis have backplanes for plug-in of the main cards, option cards, and hot-swap redundant power supplies. For other chassis, the cards are connected with a wiring harness.

**High performance models** The high performance models use a different video compression algorithm that provides visually lossless video quality suitable for applications such as broadcast, air traffic control, military, and medical applications. These models are available for dual-link DVI, HDMI 2.0, and DisplayPort 1.1 and 1.2. These units can be interchanged with one another for video conversion and audio transport, but are not compatible with the standard models.

## Specifications

<b>Dimensions (W x D x H)</b>	2 card chassis 5.7" x 5.8" x 1.7" 145 x 147 x 41 mm	2 card with IEC 8.7" x 5.8" x 1.7" 442 x 147 x 41 mm	
	4 card chassis 11.5" x 5.8" x 1.7" 293 x 147 x 41 mm	6 card chassis 17.4" x 5.8" x 1.7" 293 x 147 x 41 mm	
	6 card chassis 2xPSU 17.4" x 9.8" x 1.7" 293 x 250 x 41 mm	21 card chassis 2xPSU 19" x 18.2" x 6.9" 482 x 462 x 176 mm	
<b>Weight</b>	2 card chassis 1.5lb (0.7Kg)	2 card with IEC 2.4lb (1.1 Kg)	
	4 card chassis 2.0lb (0.9Kg)	6 card chassis 4.2lb (1.9Kg)	
	6 card chassis 2xPSU 5.5lb (2.5Kg)	21 card chassis 2xPSU 22.1lb (10.0Kg)	
<b>Power</b>	2 card chassis 100-240V, 50/60Hz, 5VDC/3A	2 card with IEC 100-240V, 50/60Hz, 5VDC/5A	
	4 card chassis 100-240V, 50/60Hz, 5VDC/5A	6 card chassis 96-264V, 47-63Hz, 5VDC/12A	
	6 card chassis 2xPSU 100-240V, 50/60Hz	21 card chassis 2xPSU 100-240V, 50/60Hz	
<b>Link cable distance</b>	CATx	460ft	140m
	Multimode OM3 50µ	3,280ft	1,000m
	Multimode 50µ	1,300ft	400m
	Multimode 62.5µ	650ft	200m
	Single-mode 9µ	32,800ft	10Km
	Single-mode 9µ, 2.5G	16,400ft	5Km
<b>Link Bandwidth</b>	CATx / Fiber 1G	1.25 Gbit/s	
	Fiber 2.5G	3.125 Gbit/s	
<b>USB</b>	USB-HID: current up to 100mA per port USB2.0: Transparent high-speed up to 480Mbps at 500mA per port USB2.0 embedded: from 36-100Mbps USB3.0: up to 5Gbps, max distance 330ft (100m) dedicated single-mode connectors requires multimode fiber cable only		
<b>Indicator LED's</b>	Standard LED's (all cards): CATx and fiber link: Active connection and connection status USB and video: 4-6 LED's including device ready, USB On, Video On, Video unknown		
<b>Environment</b>	Operating temp: 41°F – 113°F (5°C – 45°C) Storage temp: -13°F – 140°F (-25°C – 60°C) Rel. humidity: max 80% non-condensing Sound pressure level: max .21 dBA per fan		
<b>Approvals</b>	FCC Class A Part 15, IEC,EN, UL, WEEE, RoHS/RoHS2		

## Video specifications

<b>DVI resolution</b>	DVI-D/DVI-I single-link: up to 1920×1080p 1920×1200@60, 2048×1152@60 DVI-D dual-link: 2048×2048@60, 2560×1440@60, 2560×2048@60, 3840×2160@30, 4096×2160@30 DVI-D dual-head: 2 x 1920×1200@60 or 2× 1920×1152@60
<b>DVI bandwidth</b>	DVI-D/DVI-I single-link: 4.95Gbit/s DVI-D dual-link: up to 9.90Gbit/s DVI-D dual-head: up to 2× 4.95Gbit/s
<b>HDMI resolution</b>	Standard: Up to 1920×1080p, 1920×1200@60, 2048×1152@60 2.0: 3840×2160@60, 4096×2160@60
<b>HDMI bandwidth</b>	Standard: 4.95Gbit/s 24 bit (4:4:4) 2.0: 18Gbit/s 24 bit (4:4:4)
<b>DisplayPort resolution</b>	DisplayPort 1.1: Up to 1920×1080p, 1920×1200@60, 2560×2048@60, 2048×2048@60, 3840×2160@30, 4096×2160@30 (4K DCI) DisplayPort 1.2: Up to 1920×1080p, 1920×1200@60, 2560×2048@60, 2048×2048@60, 3840×2160@60, 4096×2160@60 (4K DCI)
<b>DisplayPort bandwidth</b>	DP1.1: 8.64 Gbit/s 24 bit (4:4:4) DP1.2: 21.6 Gbit/s 24 bit (4:4:4)
<b>SDI resolution</b>	720p50, 1080p50, 720p60, 1080p60, 1080i50, 1080i60, and others
<b>SDI bandwidth</b>	2.970 Gbit/s
<b>SDI color space</b>	4:2:2 10 bit (transmitter) 4:4:4 8 bit (receiver)

## Audio specifications

<b>Analog audio</b>	Format: 16 bit, 38.4Khz Signal level: Line level, 5volt Peak-Peak Impedance: 47K Ohm Input/output - 2 x 3.5mm stereo jacks Analog on USB2.0: Format: 16 bit, 8, 11.025, 16, 22.05, 32, 44.1, 48Khz Signal level: Line level, 5volt Peak-Peak Impedance: 20K Ohm Input/output – 1× USB-B / 2× 3.5mm stereo
<b>Digital audio</b>	Transmission of unidirectional audio data: Compatibility: AES/EBU, S/PDIF, EIAJ CP1201, IEC 60958 Standards: Dolby digital, DTS, PCM Bit depth: 24 bit Sample rate: 32 to 192 KHz Transmitter In: 1× Mini XLR, 1× Coaxial S/PDIF; RCA, Cinch, 1× Optical S/PDIF; TOSLINK

## Video Connectors

Card type	Transmitter	Receiver
DVI-D single-link	1× DVI-D: 29 pin(F) 1× USB: type B 1× or 2× RJ45 or LC type duplex fiber	1× DVI-D: 29 pin(F) 2× USB: type A 1 or 2× RJ45 or LC type duplex fiber
DVI-I VGA (VGA no scaling)	1× DVI-I: 29 pin(F) 1× USB: type B 1× or 2× RJ45 or LC type duplex fiber	1× DVI-I: 29 pin(F) 2× USB: type A 1 or 2× RJ45 or LC type duplex fiber
DVI-I VGA (VGA with full scaling, dual- height card)	1× DVI-I: 29 pin(F) 1× USB: type B 1× IR remote ctrl 1× RJ45 or LC type duplex fiber	1× DVI-D: 29 pin(F) 2× USB: type A 1× IR remote ctrl 1× RJ45 or LC type duplex fiber
DVI-D dual-link and dual-head	1× DMS: 59 pin(F) 1× USB: type B 1× or 2× RJ45 or LC type duplex fiber	1× DMS: 59 pin(F) 2× USB: type A 1× or 2× RJ45 or LC type duplex fiber
HDMI	1× HDMI:(F) 1× USB: type B 1× or 2× RJ45 or LC type duplex fiber	1× HDMI:(F) 2× USB: type A 1 or 2× RJ45 or LC type duplex fiber
HDMI with local port	2× HDMI:(F) 1× USB: type B 1× or 2× RJ45 or LC type duplex fiber	
HDMI with switch port		2× HDMI:(F) 2× USB: type A 1× USB: type B 1 or 2× RJ45 or LC type duplex fiber
HDMI video only	1× HDMI:(F) 1× RJ45 or LC type duplex fiber	1× HDMI:(F) 1× RJ45 or LC type duplex fiber
DisplayPort	1× DisplayPort:(F) 1× USB: type B 1× or 2× RJ45 or LC type duplex fiber	1× DisplayPort:(F) 2× USB: type A 1 or 2× RJ45 or LC type duplex fiber
SDI main card	2× dual BNC mini- coax 1× or 2× RJ45 or LC type duplex fiber	2× dual BNC mini- coax 1 or 2× RJ45 or LC type duplex fiber

All cards above include 1x micro USB jack as service port

## Other Connectors

Card type	Transmitter	Receiver
USB-HID	1× USB type B	2× USB type A
Embedded USB2	1× USB type B	2× USB type A
Embedded USB2	1× USB type B	4× USB type A
Embedded USB2 + analog audio	1× USB type B	2× USB type B 2× 3.5mm audio
Audio + serial (RS232 or RS422)	2× 3.5mm audio jack 1× DB9 serial (F)	2× 3.5mm audio jack 1× DB9 serial (M)
Audio + serial + PS2	2× 3.5mm audio jack 1× DB9 serial (F) 2× PS2 mini-din6F	2× 3.5mm audio jack 1× DB9 serial (M) 2× PS2 mini-din6F
Balanced analog audio unidirectional	1× 48V phantom power switch 2× audio in ¼" jack 2× DIP gain switch	2× audio out ¼" jack 2× DIP gain switch
Digital audio	1× S/PDIF-RCA 1× AES/EBU-Mini-XLR 1× S/PDIF-TOSLINK	1× S/PDIF-RCA 1× AES/EBU-Mini- XLR 1× S/PDIF-TOSLINK
USB2.0 high- speed	1× USB: type B 1× USB: mini-service 1× or 2× RJ45 or LC type duplex fiber	4× USB: type A 1× USB: mini- service 1× or 2× RJ45 or LC type duplex fiber
USB3.0 SuperSpeed	1× USB3.0-B 1× LC duplex fiber 2.5Gbps	2× USB3.0-A 1× LC duplex fiber 2.5Gbps
Push Button		1× push-button
SNMP monitoring		1× DB9 serial 1× RJ45

## Part numbers

The Orion Xtender is a highly configurable product and has many variations. In order to accommodate all of the variations and options, the part numbering system is described herein.

Product part numbers consist of a chassis and power options with one or more main transmitter or receiver cards installed into the chassis with zero or more option cards.

The variations of the main card as listed in Table 1 and shown in Table 6 on page 16 consist of:

- Transmitter or receiver
- With or without redundant link
- Media type either CATx, Fiber 1G, or Fiber 2.5G
- Regular or high performance video, these are not-compatible with one another
- Video type:
  - 11 variations of standard performance (not compatible with high performance models)
  - 4 variations of high performance (not compatible with standard performance models)

To make the part number you must specify six things:

1. The main card part number from Table 1
2. The quantity of main cards (b)
3. The option card part number from Table 2
4. The quantity of option cards (c)
5. The chassis size (a) from table 3
6. The power options (p) from Table 3

The part number is then formed:

Chassis	—	Main card	/	Option card	/	Power option
<hr/>		<hr/>		<hr/>		<hr/>
Part number from Table 1		Part number from table 2		Power option (p) from Table 3		
a = Chassis size from Table 3		c = Quantity of option cards				
b = Quantity of main cards						

### Stacking part numbers

When different styles of main cards or option cards are desired then just append the second type to the first type separated by /.

### Orion XTender: 21-Card Rack Chassis

The Orion XTender 21-card chassis is 4U high. When installed in a computer rack, it saves considerable rack space compared to the individual Orion 2/4/6 card chassis and it significantly reduces the power consumption for an equivalent number of stand-alone transmitter or receiver chassis.

Any combination of Orion XTender main card and option cards can be installed in the chassis, up to a maximum of 21 cards. Each Orion option card needs to be installed adjacent to an Orion main card. Blanking plates are available for covering unused chassis slots, see Table 4.

**Table 1. Part number with main card installed into chassis (a) and main card quantity (b)**

Card type	High perf.	Transmitter			Receiver		
		CATx	Fiber 1G	Fiber 2.5G	CATx	Fiber 1G	Fiber 2.5G
DVI-D		OTa-SLDTXUDbD	OTa-SLDFSUDbD	OTa-SLDF3UDbD	ORa-SRDTXUDbD	ORa-SRDFSUDbD	ORa-SRDF3UDbD
DVI-I VGA		OTa-SLDTXUSbV	OTa-SLDFSUSbV	—	ORa-SRDTXUSbV	ORa-SRDFSUSbV	—
DVI-I VGA scaling*		OTa-SLDTXUDbV	OTa-SLDFSUDbV	OTa-SLDF3UDbV	ORa-SRDTXUDbV	ORa-SRDFSUDbV	ORa-SRDF3UDbV
DVI Dual-link		OTa-SLDTXUDLb	OTa-SLDFSUDLb	OTa-SLDF3UDLb	ORa-SRDTXUDLb	ORa-SRDFSUDLb	ORa-SRDF3UDLb
DVI Dual-head		OTa-SLDTXUSLb	OTa-SLDFSUSLb	OTa-SLDF3USLb	ORa-SRDTXUSLb	ORa-SRDFSUSLb	ORa-SRDF3USLb
HDMI		OTa-SLDTXUHbH	OTa-SLDFSUHbH	—	ORa-SRDTXUHbH	ORa-SRDFSUHbH	—
HDMI video only**		OTa-SLDTX0HbH	OTa-SLDFS0HbH	—	ORa-SRDTX0HbH	ORa-SRDFS0HbH	—
HDMI local video*		OTa-DLDTXUHbH	OTa-DLDFSUHbH	—	—	—	—
HDMI remote PC*		—	—	—	ORa-DRDTXUHbW	ORa-DRDFSUHbW	—
DP 1.1		OTa-SLDTXUDPb	OTa-SLDFSUDPb	OTa-SLDF3UDPb	ORa-SRDTXUDPb	ORa-SRDFSUDPb	ORa-SRDF3UDPb
SDI		OTa-DLDTXOSDb	OTa-DLDFSOSDb	OTa-DLDF3OSDb	ORa-DRDTXOSDb	ORa-DRDFSOSDb	ORa-DRDF3OSDb
DVI Dual-link +	✓	OTa-SLDTXUDXb	OTa-SLDFSUDXb	OTa-SLDF3UDXb	ORa-SRDTXUDXb	ORa-SRDFSUDXb	ORa-SRDF3UDXb
HDMI 2.0 +	✓	—	—	OTa-SLDF3UHXb	—	—	ORa-SRDF3UHXb
DP 1.1 +	✓	OTa-SLDTXUJXb	OTa-SLDFSUJXb	OTa-SLDF3UJXb	ORa-SRDTXUJXb	ORa-SRDFSUJXb	ORa-SRDF3UJXb
DP 1.2 +	✓	OTa-SLDTXUPXb	—	OTa-SLDF3UPXb	—	—	ORa-SRDF3UPXb
Card type		Transmitter with redundant link			Receiver with redundant link		
		CATx	Fiber 1G	Fiber 2.5G	CATx	Fiber 1G	Fiber 2.5G
DVI-D		OTa-SLD2CUDbD	OTa-SLD2SUDbD	OTa-SLD23UDbD	ORa-SRD2CUDbD	ORa-SRD2SUDbD	ORa-SRD23UDbD
DVI-I VGA		OTa-SLD2CUSbV	OTa-SLD2SUSbV	—	ORa-SRD2CUSbV	OTa-SRD2SUSbV	—
DVI-I VGA scaling*		OTa-SLD2CUDbV	OTa-SLD2SUDbV	OTa-SLD23UDbV	ORa-SRD2CUDbV	ORa-SRD2SUDbV	ORa-SRD23UDbV
DVI Dual-link		OTa-SLD2CUDLb	OTa-SLD2SUDLb	OTa-SLD23UDLb	ORa-SRD2CUDLb	ORa-SRD2SUDLb	ORa-SRD23UDLb
DVI Dual-head		OTa-SLD2CUSLb	OTa-SLD2SUSLb	OTa-SLD23USLb	ORa-SRD2CUSLb	ORa-SRD2SUSLb	ORa-SRD23USLb
HDMI 1.4		OTa-SLD2CUHbH	OTa-SLD2SUHbH	—	ORa-SRD2CUHbH	ORa-SRD2SUHbH	—
HDMI video only**		OTa-SLD2C0HbH	OTa-SLD2S0HbH	—	ORa-SRD2C0HbH	ORa-SRD2S0HbH	—
HDMI local video*		OTa-DLD2CUHbH	OTa-DLD2SUHbH	—	—	—	—
HDMI remote PC		—	—	—	ORa-DRD2CUHbW	ORa-DRD2SUHbW	—
DP 1.1		OTa-SLD2CUDPb	OTa-SLD2SUDPb	OTa-SLD23UDPb	ORa-SRD2CUDPb	ORa-SRD2SUDPb	ORa-SRD23UDPb
SDI		OTa-DLD2C0SDb	OTa-DLD2S0SDb	OTa-DLD230SDb	ORa-DRD2C0SDb	ORa-DRD2S0SDb	ORa-DRD230SDb
DVI Dual-link +	✓	OTa-SLD2CUDXb	OTa-SLD2SUDXb	OTa-SLD23UDXb	ORa-SRD2CUDXb	ORa-SRD2SUDXb	ORa-SRD23UDXb
HDMI 2.0 +	✓	—	—	OTa-SLD23UHXb	—	—	ORa-SRD23UHXb
DP 1.1 +	✓	OTa-SLD2CUJXb	OTa-SLD2SUJXb	OTa-SLD23UJXb	ORa-SRD2CUJXb	ORa-SRD2SUJXb	ORa-SRD23UJXb
DP 1.2 +	✓	OTa-SLD2CUPXb	—	OTa-SLD23UPXb	—	—	ORa-SRD23UPXb





\* Full height card requires 4-card or 6-card chassis to accommodate option card  
 \*\* HDMI video only does not support option cards

**Table 2. Part number of option card when installed into chassis with number of option cards (c)**

Part number	Description
cH	USB-HID
cE	Embedded USB 2.0, two device ports on receiver, up to 36 Mbps
cF	Embedded USB 2.0, flex speed, four device ports on receiver , up to 100 Mbps
cAS	Analog Audio + RS232
cA4	Analog Audio + RS422
cAS+cPS	Analog Audio + RS232 + PS/2
cAS+cH	Analog Audio + RS232 + USB-HID
cA4+cH	Analog Audio + RS422 + USB-HID
cAS+cE	Analog Audio + RS232 + Embedded USB 2.0
cA4+cE	Analog Audio + RS422 + Embedded USB 2.0
cAB	Analog audio, balanced, two channels, 9 - 60 dB preamplifier and 48V phantom power
cDA	Digital Audio
cDA+cH	Digital Audio + USB-HID
cDA+cE	Digital Audio + Embedded USB 2.0, two device ports on receiver, up to 36 Mbps
cDD	Digital Audio, bidirectional
cAS+cDA	Digital Audio + Analog Audio + RS232
cPB	Push button for displaying OSD on receiver unit for user with no keyboard
SNMP	Monitoring module with SNMP, Ethernet, and RS232 for CH07 and CH21 chassis only

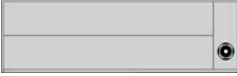
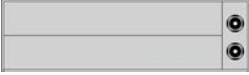
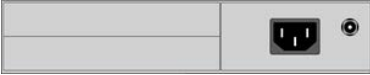
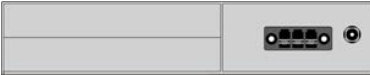
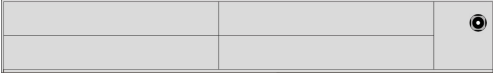

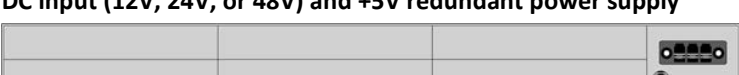
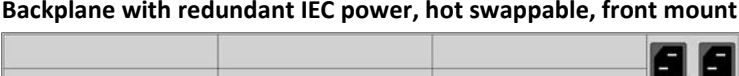
**Table 3. Chassis options**

Chassis size (a)	Power option (p)	Part number Chassis only	
2		OEE-CH02	Standard +5 power supply 
2	/RP <sup>1</sup> /DP <sup>2</sup>	OEE-CH02/DP	Redundant +5 power supplies 
3	/RP <sup>0</sup> /DP <sup>1</sup>	OEE-CH03/DP	Standard IEC power and +5V redundant power 
3	/D12 /D24 /D48	OEE-CH03/D12 OEE-CH03/D24 OEE-CH03/D48	DC input (12V, 24V, or 48V) and +5V redundant power supply 
4		OEE-CH04/DP	Standard +5 power supply 
4	/RP <sup>1</sup> /DP <sup>2</sup>	OEE-CH04/DP	Redundant +5 power supplies 
6	/RP <sup>0</sup> /DP <sup>1</sup>	OEE-CH06/DP	Standard IEC power and +5V redundant power 
6	/D12 /D24 /D48	OEE-CH06/D12 OEE-CH06/D24 OEE-CH06/D48	DC input (12V, 24V, or 48V) and +5V redundant power supply 
7	/BPF/DP	OEE-CH06/BPF/DP	Backplane with redundant IEC power, hot swappable, front mount 
7	/BPB/DP	OEE-CH06/BPB/DP	Backplane with redundant IEC power, hot swappable, rear mount 
<p><sup>0</sup> Ships with no external power supply  <sup>1</sup> Ships with one external power supply  <sup>2</sup> Ships with two external power supplies</p>			

**Table 3. Continued**

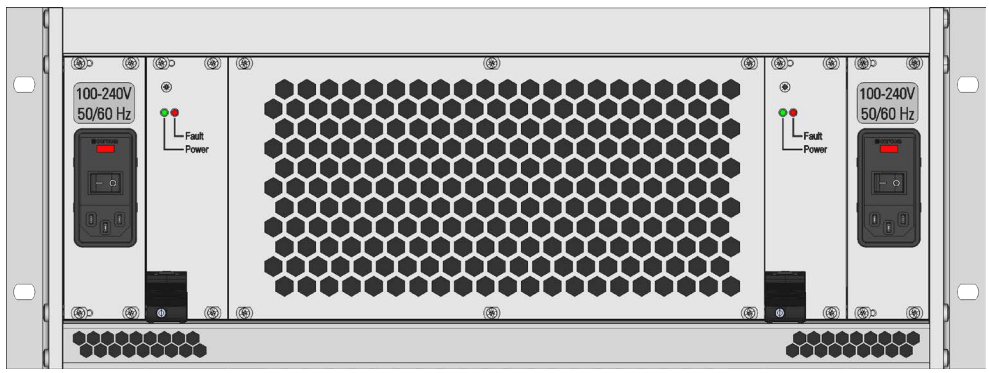
Chassis size (a)	Power option (p)	Part number Chassis only	
21	/RP <sup>1</sup> /DP <sup>2</sup>	OEE-CH21/RP OEE-CH21/DP	
<sup>1</sup> Ships with one installed power supply <sup>2</sup> Ships with two installed power supplies			

**Table 4. Mounting brackets and accessories**

Part number	Description
RM-OEE-02/19	19" rackmount kit for chassis size 2
RM-OEE-03/19	19" rackmount kit for chassis size 3
RM-OEE-04/19	19" rackmount kit for chassis size 4
RM-OEE-06/19	19" rackmount kit for chassis size 6 and 7
RM-OEE-TRAY/19	Rackmount Tray, 1U 19", for 2, 4, or 6 card chassis
RM-OEE-UD	Under desk mounting brackets, for 2, 4, or 6 card chassis
RM-OEE-DR-PLT	DIN Rail Mounting Brackets, with clips, for 2, 4, or 6 card chassis
OEE-CP01/CH21	1 slot blanking plate for 21-card chassis
OEE-CP02/CH21	2 slot blanking plate for 21-card chassis
OEE-CP04/CH21	4 slot blanking plate for 21-card chassis
FAN-OEE-CH07	Optional fan for chassis size 7, may be required, contact Rose

**Figure 1. Various cards installed in two card chassis**



**DVI ■ USB-HID ■ Fiber  
USB2.0 Embedded ■ Audio ■ Serial**

OR2-SRDFSUD1D/1AS+1E (top)  
OT2-SLDFSUD1D/1AS+1E (bottom)



**Dual link DVI ■ USB-HID ■ CATx  
High performance**

OR2-SRDTXUDX1 (top)  
OT2-SLDTXUDX1 (bottom)



**HDMI with local video ■ USB-HID ■ CATx  
Redundant +5V power supplies**

OR2-SRDTXUH1H/DP (top)  
OT2-DLDTXUH1H/DP (bottom)



**Display Port 1.1 ■ USB HID ■ CATx  
Redundant link**

OR2-SRD2CUDP1 (top)  
OT2-SLD2CUDP1 (bottom)



**Display Port 1.2 ■ USB HID ■ Fiber  
Redundant link ■ High performance**

OR2-SRD23UPX1 (top)  
OT2-SLD23UPX1 (bottom)



**SDI source to HDMI display ■ CATx  
(Video only)**

OR2-SRDTX0H1H (top)  
OT2-DLDTX0SD1 (bottom)



**Dual-head DVI ■ USB HID ■ Fiber ■ Standard  
IEC power and +5V redundant power**

OT3-SLDFSUSL2/DP (top)  
OR3-SRDFSUSL2/DP (bottom)



**DVI-I (DVI and VGA) ■ USB HID ■ CATx**

OT2-SLDTXUD1V (top)  
Front side of chassis (bottom)



**DisplayPort 1.1 ■ USB HID ■ Fiber  
Audio ■ Serial ■ 48V DC input**

OT2-SLDFSUDP1/D48

**Figure 2. Various cards installed in four card chassis**



**OT4-SLDFSUD3D**

**OR4-SRDFSUD3D**

**Main card: DVI ■ USB-HID ■ Fiber**

**Option card: None**

**Power option: Standard**



**OT4-SLDTXUH2H/2AS**

**OR4-SRDTXUH2/2AS**

**Main card: HDMI ■ USB-HID ■ CATx**

**Option card: Serial ■ Audio**

**Power option: Redundant +5 power supplies**



**OT4-SLDFSUD2D/2AS+2E**

**OR4-SRDFSUD2D/2AS+2E**

**Main card: DVI ■ USB-HID ■ Fiber**

**Option card: USB 2.0 embedded ■ Serial ■ Audio**

**Power option: Standard**

**Figure 3. Various cards installed in six card chassis**



**OR6-SRDFSUS3V/1PS/1AS+1E/DP**

**OT6-SLDFSUS3V/1PS/1AS+1E/DP**

**Main card: DVI-I (VGA/DVI) ■ USB-HID ■ Fiber**  
**Option cards: PS/2 keyboard/mouse ■ Audio ■ Serial ■ USB-embedded**  
**Power option: Standard**



**OR6-SRDTXUH3H/3E/DP**

**OT6-SLDTXUH3H/3E/DP**

**Main card: HDMI ■ USB-HID ■ CATx**  
**Option card: USB 2.0 embedded**  
**Power option: Standard**



**OR7-SRDFSUDP3/3AS/BPF/DP**

**OT7-SLDFSUDP3/3AS/BPF/DP**

**Main card: DisplayPort 1.1 ■ USB-HID ■ Fiber**  
**Option card: Audio ■ Serial**  
**Power option: Backplane with redundant IEC power, hot swappable, front mount**



**OT7-SLDFSUDL4/BPF/DP**

**OR7-SRDFSUDL4/BPF/DP**

**Main card: Dual-link DVI ■ USB-HID ■ Fiber**  
**Option card: None**  
**Power option: Backplane with redundant IEC power, hot swappable, front mount**

**Figure 4. Various cards installed in 21-card chassis**



**Orion XTender 21 card chassis with transmitter cards installed**

4 × DVI-D/USB-HID with the audio/serial/embedded USB2.0 option card, CATx  
3 × DVI-D/USB-HID with the embedded USB2.0 option card, CATx  
7 × DVI-D/USB-HID cards, CATx



**Orion XTender 21 card chassis with transmitter cards installed**

21 × DVI-D/USB-HID cards, CATx



**Orion XTender 21 card chassis with receiver cards installed (top)**

8 × DVI-D/USB-HID cards, fiber

**Orion XTender 21 card chassis with receiver cards installed (bottom)**

8 × DVI-D/USB-HID cards, fiber



**Orion XTender 21 card chassis – back panel**

Chassis configured with optional redundant power supply and locking connectors for each power supply

**Table 5. Part numbers for main card when specified without chassis**

TRANSMITTER	RECEIVER	Figure	DVI-D	DVI-I VGA	HDMI	DP	SDI	USB	CATx	Fiber	2G/3G Fiber	2nd Link	Special Feature
OEC-SLDTXUD1D/IRK	OEC-SRDTXUD1D/IRK	A	X					HID	X				
OEC-SLDFSUD1D/IRK	OEC-SRDFSUD1D/IRK	A						HID		X			
OEC-SLDF3UD1D/IRK	OEC-SRDF3UD1D/IRK	A	X					HID			X		
OEC-SLD2CUD1D/IRK	OEC-SRD2CUD1D/IRK	B	X					HID	X			X	
OEC-SLD2SUD1D/IRK	OEC-SRD2SUD1D/IRK	B	X					HID		X		X	
OEC-SLDTXUS1V/IRK	OEC-SRDTXUS1V/IRK	C		X				HID	X				
OEC-SLDFSUS1V/IRK	OEC-SRDFSUS1V/IRK	C		X				HID		X			
OEC-SLD2CUS1V/IRK	OEC-SRD2CUS1V/IRK	D		X				HID	X			X	
OEC-SLD2SUS1V/IRK	OEC-SRD2SUS1V/IRK	D		X				HID		X		X	
OEC-SLDTXUD1V/IRK		E		X				HID	X				Scaling
OEC-SLDFSUD1V/IRK		E		X				HID		X			Scaling
OEC-SLDF3UD1V/IRK		E		X				HID			X		Scaling
OEC-SLDTXUDL1/IRK	OEC-SRDTXUDL1/IRK	F	X					HID	X				Dual-link DVI
OEC-SLDFSUDL1/IRK	OEC-SRDFSUDL1/IRK	F	X					HID		X			Dual-link DVI
OEC-SLDF3UDL1/IRK	OEC-SRDF3UDL1/IRK	F	X					HID			X		Dual-link DVI
OEC-SLD2CUDL1/IRK	OEC-SRD2CUDL1/IRK	G	X					HID	X			X	Dual-link DVI
OEC-SLD2SUDL1/IRK	OEC-SRD2SUDL1/IRK	G	X					HID		X		X	Dual-link DVI
OEC-SLD23UDL1/IRK	OEC-SRD23UDL1/IRK	G	X					HID			X	X	Dual-link DVI
OEC-SLDTXUSL1/IRK	OEC-SRDTXUSL1/IRK	H	X					HID	X				Dual-head
OEC-SLDFSUSL1/IRK	OEC-SRDFSUSL1/IRK	H	X					HID		X			Dual-head
OEC-SLDF3USL1/IRK	OEC-SRDF3USL1/IRK	H	X					HID			X		Dual-head
OEC-SLD2CUSL1/IRK	OEC-SRD2CUSL1/IRK	I	X					HID	X			X	Dual-head
OEC-SLD2SUSL1/IRK	OEC-SRD2SUSL1/IRK	I	X					HID		X		X	Dual-head
OEC-SLD23USL1/IRK	OEC-SRD23USL1/IRK	I	X					HID			X	X	Dual-head
OEC-SLDTX0H1H/IRK	OEC-SRDTX0H1H/IRK	J			X			NONE	X				
OEC-SLDFS0H1H/IRK	OEC-SRDFS0H1H/IRK	J			X			NONE		X			
OEC-SLDTXUH1H/IRK	OEC-SRDTXUH1H/IRK	K			X			HID	X				
OEC-SLDFSUH1H/IRK	OEC-SRDFSUH1H/IRK	K			X			HID		X			
OEC-SLD2CUH1H/IRK	OEC-SRD2CUH1H/IRK	L			X			HID	X			X	
OEC-SLD2SUH1H/IRK	OEC-SRD2SUH1H/IRK	L			X			HID		X		X	
OEC-DLDTXUH1H/IRK		M			X			HID	X				Local HDMI out
OEC-DLDFSUH1H/IRK		M			X			HID		X			Local HDMI out
OEC-DLD2CUH1H/IRK		N			X			HID	X			X	Local HDMI out
OEC-DLD2SUH1H/IRK		N			X			HID		X		X	Local HDMI out
	OEC-DRDTXUH1HW/IRK	O			X			HID	X				KVM switch
	OEC-DRDFSUH1HW/IRK	O			X			HID		X			KVM switch
	OEC-DRD2CUH1HW/IRK	P			X			HID	X			X	KVM switch
	OEC-DRD2SUH1HW/IRK	P			X			HID		X		X	KVM switch
OEC-SLDTXUDP1/IRK	OEC-SRDTXUDP1/IRK	Q				X		HID	X				4K @30Hz
OEC-SLDFSUDP1/IRK	OEC-SRDFSUDP1/IRK	Q				X		HID		X			4K @30Hz
OEC-SLDF3UDP1/IRK	OEC-SRDF3UDP1/IRK	Q				X		HID			X		4K @30Hz
OEC-SLD2CUDP1/IRK	OEC-SRD2CUDP1/IRK	R				X		HID	X			X	4K @30Hz
OEC-SLD2SUDP1/IRK	OEC-SRD2SUDP1/IRK	R				X		HID		X		X	4K @30Hz
OEC-SLD23UDP1/IRK	OEC-SRD23UDP1/IRK	R				X		HID			X	X	4K @30Hz
OEC-SLDF3UPX1/IRK	OEC-SRDF3UPX1/IRK	Q				X		HID			X		4K @60Hz
OEC-SLD23UPX1/IRK	OEC-SRD23UPX1/IRK	R				X		HID			X	X	4K @60Hz
OEC-DLDTX0SD1/IRK	OEC-DRDTX0SD1/IRK	S					X	HID	X		X		2x SDI
OEC-DLDFS0SD1/IRK	OEC-DRDFS0SD1/IRK	S					X	HID		X			2x SDI
OEC-DLDF30SD1/IRK	OEC-DRDF30SD1/IRK	S					X	HID			X		2x SDI
OEC-DLD2C0SD1/IRK	OEC-DRD2C0SD1/IRK	T					X	HID	X			X	2x SDI
OEC-DLD2S0SD1/IRK	OEC-DRD2S0SD1/IRK	T					X	HID		X		X	2x SDI
OEC-DLD230SD1/IRK	OEC-DRD230SD1/IRK	T					X	HID			X	X	2x SDI
OEC-SLDTXU000/IRK	OEC-QRDTXU000/IRK						U	2.0	X				
OEC-SLDFSU000/IRK	OEC-QRDFSU000/IRK							2.0		X			
OEC-SLD2CU000/IRK	OEC-QRD2CU000/IRK							2.0	X		X		
OEC-SLD2SU000/IRK	OEC-QRD2SU000/IRK							2.0		X	X		
OEC-SLDFMR000/IRK	OEC-QRDFMR000/IRK							3.0		X			

**Table 6. Main card connection panels**

**DVI/VGA + USB-HID**

	CPU - Transmitter Card	User - Receiver Card
<b>A</b>		
	USB-HID, DVI-D	
<b>B</b>		
	USB-HID, DVI-D, redundant link	
<b>C</b>		
	USB-HID, DVI-I/VGA	
<b>D</b>		
	USB-HID, DVI-I/VGA, redundant link	
<b>E</b>		
	USB-HID, DVI-I/VGA (full video scaling)	
<b>F</b>		
	USB-HID, DMS-59 (DVI-D dual-link)	
<b>G</b>		
	USB-HID, DMS-59 (DVI-D dual-link), redundant link	
<b>H</b>		
	USB-HID, DMS-59 (DVI-D dual-head)	
<b>I</b>		
	USB-HID, DMS-59 (DVI-D dual-head), redundant link	

**DISPLAYPORT + USB-HID**

	CPU - Transmitter Card	User - Receiver Card
<b>Q</b>		
	USB-HID, DisplayPort	
<b>R</b>		
	USB-HID, DisplayPort, redundant link	

**SDI VIDEO**

	CPU - Transmitter Card	User - Receiver Card
<b>S</b>		
	Dual SDI	
<b>T</b>		
	Dual SDI, redundant link	

**HDMI + USB-HID**

	CPU - Transmitter Card	User - Receiver Card
<b>J</b>		
	HDMI video only	
<b>K</b>		
	USB-HID, HDMI	
<b>L</b>		
	USB-HID, HDMI, redundant link	
<b>M</b>		
	USB-HID, HDMI, and local HDMI monitor	
<b>N</b>		
	USB-HID, HDMI, and local HDMI monitor	
<b>O</b>		
	USB-HID, HDMI, KVM switch function for PC	
<b>P</b>		
	USB-HID, HDMI, KVM switch function for PC, redundant link	

**USB2.0 AND USB3.0, HIGH SPEED**

<b>U</b>		
	USB2.0 (High-speed, 480Mbps)	
<b>V</b>		
	USB2.0 (High-speed, 480Mbps), redundant link	
<b>W</b>		
	USB3.0 (100Mbps), Link port for use with multimode fiber only	

Notes:

1. VGA on cards C and D passes video through at same resolution or can scale to 1920x1080 or 1920x1200. Card E has OSD with full scaling capabilities.
2. Dual-link and dual-head cards F, G, H, and I use DMS-59 connectors and are supplied with an adapter cable.



**Table 7. Part numbers for option cards when specified without chassis**

TRANSMITTER	RECEIVER	Figure	Description
OEC-L1H	OEC-R1H	U1	USB-HID
OEC-L1E	OEC-R1E	U2	Embedded USB 2.0, two device ports on receiver, up to 36 Mbps
OEC-L1F	OEC-R1F	U3	Embedded USB 2.0, flex speed, four device ports on receiver , up to 100 Mbps
OEC-L1AS	OEC-R1AS	A1	Analog Audio + RS232
OEC-L1A4	OEC-R1A4	A1	Analog Audio + RS422
OEC-L1AS+1PS	OEC-R1AS+1PS	A2	Analog Audio + RS232 + PS/2
OEC-L1AS+1H	OEC-R1AS+1H	A3	Analog Audio + RS232 + USB-HID
OEC-L1A4+1H	OEC-R1A4+1H	A3	Analog Audio + RS422 + USB-HID
OEC-L1AS+1E	OEC-R1AS+1E	A4	Analog Audio + RS232 + Embedded USB 2.0
OEC-L1A4+1E	OEC-R1A4+1E	A4	Analog Audio + RS422 + Embedded USB 2.0
OEC-L1AB	OEC-R1AB	A5	Analog audio, balanced, two channels, 9 - 60 dB preamplifier and 48V phantom power
OEC-L1DA	OEC-R1DA	D1	Digital Audio
OEC-L1DA+1H	OEC-R1DA+1H	D2	Digital Audio + USB-HID
OEC-L1DA+1E	OEC-R1DA+1E	D3	Digital Audio + Embedded USB 2.0, two device ports on receiver, up to 36 Mbps
OEC-L1DD	OEC-R1DD	D4	Digital Audio, bidirectional
OEC-L1AS+1DA	OEC-R1AS+1DA	D5	Digital Audio + Analog Audio + RS232
	OEC-R1PB	PB	Push button for displaying OSD on receiver unit for user with no keyboard
	OEC-SNMP	SN	Monitoring module with SNMP, Ethernet, and RS232 for CH07 and CH21 chassis only

**Table 8. Option card connection panels**

	CPU - Transmitter Card	User - Receiver Card		CPU - Transmitter Card	User - Receiver Card
<b>U1</b>					
	USB-HID for keyboard and mouse			Digital Audio (RCA, Mini XLR, TOSLINK)	
<b>U2</b>					
	USB2.0 embedded 2x USB-A ports, full speed			Digital Audio (RCA, Mini XLR, TOSLINK), USB-HID	
<b>U3</b>					
	USB2.0 embedded 4x USB-A ports, flex speed			Digital Audio (RCA, Mini XLR, TOSLINK), USB2.0 embedded	
<b>A1</b>					
	RS-232/RS422 Serial (DB9), Analog Audio			Digital Audio Bidirectional	
<b>A2</b>					
	RS-232/RS422 Serial (DB9), Analog Audio, PS2 keyboard and mouse			Digital Audio, RS-232 Serial (DB9), Analog Audio	
<b>A3</b>				<b>PB</b>	
	RS-232/RS422 Serial (DB9), Analog Audio, USB-HID			Push button for displaying OSD on receiver unit for user with no keyboard	
<b>A4</b>				<b>SN</b>	
	RS-232/RS422 Serial (DB9), Analog Audio, USB2.0 embedded			SNMP Module. TCP/IP + RS232	
<b>A5</b>					
	Balanced Analog Audio, for microphones or other devices				

The maximum speed for USB 2.0 embedded on option cards is 100 Mbps. For faster speed, use the USB 2.0 (480Mbps) or USB 3.0 (5Gbps) main cards U, V, and W.

---

**WWW.ROSE.COM** ▪ **sales@rose.com** ▪ **(800) 333-9343**

Rose Electronics ▪ 10707 Stancliff Road ▪ Houston, Texas 77099  
Rose USA (281) 933-7673 ▪ Rose Europe +49 (0) 2454 969442  
Rose Asia +65 6324 2322 ▪ Rose Australia +61 (0) 421 247083

datasheet-orion-xtender-2018-03-08

